

VLine

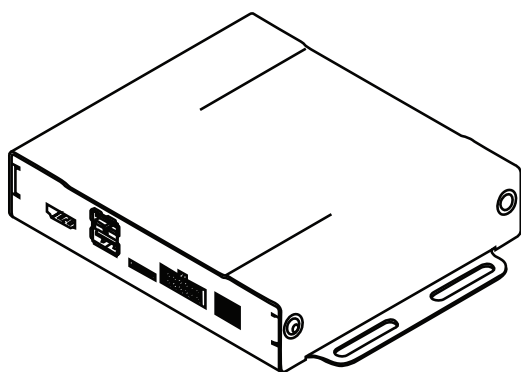

INSTALLATION MANUAL

CHRU

CONTENTS

Package contents.....	3
CHAPTER 1 — INSTALLATION.	3
1.1 Before Installation	3
1.2 Tools	3
1.3 Vehicle Installation	3
1.4 Safety Guidelines & Appropriate Use	4
Connect supplied cables to car stereo.	5
Connect VLine Interface cable to factory head unit.	6
Connecting to VLine.....	6
Routing the GPS Antenna.....	7
Using factory microphone.....	7
Adjusting the microphone gain	8
Testing the VLine operation	8
Mounting the VLine module.....	8
Understanding the VLine ports.	9
CHAPTER 2 — GETTING STARTED.....	11
SUPPORT.	13
WARRANTY.	13
EIGHTEEN MONTH (18) LIMITED WARRANTY	
GRANT OF LICENSE.....	14
OPERATIONAL WARNING AND SAFETY INSTRUCTIONS.	15

GROM-VLINE SYSTEM

PACKAGE CONTENTS

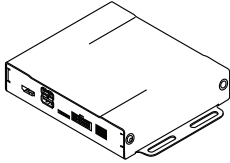

VLine module



MCFCHRU
Power and Display Harness



CHRUMINIUSB
USB cable

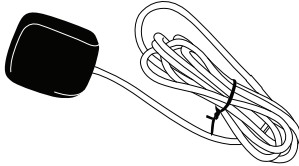

GPS Antenna

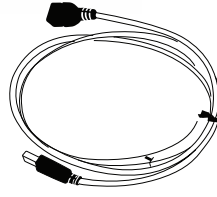

USB Extension cable

CHAPTER 1 — INSTALLATION

1.1 Before Installation

Before starting work with any wiring, please wait 90 seconds after turning the Ignition to the OFF position and disconnecting the negative (-) terminal of the battery. This is to ensure that no SRS airbags faults are triggered during the installation when disassembling the vehicle's panels and wiring connections for the VLINE module installation.

Please review the entire manual to familiarize yourself of the VLINE module and the installation requirements before installing the unit and using it.

1.2 Tools

Have tools ready for disassembling the dashboard panels to remove the stereo.

Some basic tools will be required for stereo removal and installation, Plastic prying tools, Phillips head screwdriver, 10mm socket and ratchet. Additional tools may be required depending on vehicle and installation preference.

1.3 Vehicle Installation

Each model vehicle disassembles differently. The removal of the stereo and

wiring installation requires special technical skills and experience. If you do not feel comfortable doing the installation please consult with your local car audio shop or installation professional for instructions or assistance if necessary.

Carefully remove the factory stereo and display out of the dash cavity with proper tools.

It may be necessary to disconnect items surrounding the stereo and display to remove them and gain access to the back of the stereo to make your connections.

1.4 Safety Guidelines & Appropriate Use

By using VLine you agree:

- to operate VLine only when there are safe driving conditions;
- to follow any applicable state and traffic laws;
- to keep an eye on the road at all time while driving;
- do not attempt to play video (such as YouTube) on a display while the vehicle is in motion;
- do not use VLine without running the engine for the extended period of time as it can drain the battery.

Do not use Vline in a manner that would distract the driver or that may otherwise cause injury or death to vehicle occupants or bystanders.

IT IS ILLEGAL IN MOST STATES OF THE UNITED STATES AND MAY BE ILLEGAL IN OTHER JURISDICTIONS FOR ANY TELEVISION OR OTHER VIDEO DISPLAY, STREAM, TRANSMISSION OR BROADCAST TO BE VISIBLE TO THE DRIVER WHILE THE VEHICLE IS IN MOTION. YOU AGREE NOT TO USE ANY VISUAL COMPONENT OF VLine WHILE IN CONTROL OF A MOVING VEHICLE WHERE DOING SO WOULD BE ILLEGAL OR DANGEROUS TO VEHICLE OCCUPANTS OR BYSTANDERS. DOING OTHERWISE CAN LEAD TO SERIOUS INJURY OR DEATH TO YOU AND OTHERS. PLEASE FIND A SAFE PLACE TO PARK AND ENGAGE THE PARKING BRAKE BEFORE VIEWING ANY VIDEO DISPLAYS, STREAMS, TRANSMISSION, OR BROADCAST AVAILABLE THROUGH VLIN.



Watch install video: bit.ly/chruvl2_install

Connect supplied power and video cable MCFCHRU, and CHRUMINIUSB USB cable to the back of the factory car stereo

Locate the main stereo harness at the back of the stereo. Disconnect the factory stereo harness from the back of the stereo by gently pushing up the clip connector. Plug the MCFCHRU cable instead, as shown below, and gently push the clip down to secure the connection. Reconnect the factory stereo harness back to the female end of the MCFCHRU cable and gently push the clip down to secure the connection.

Locate the factory USB cable at the back of the stereo. Disconnect it and connect the CHRUMINIUSB USB cable instead. Leave the factory USB cable disconnected.

You will lose the factory USB function upon installing of the CHRUVL2 VLine System, but you will gain the same USB functionality using the VLine VL2 system USB.

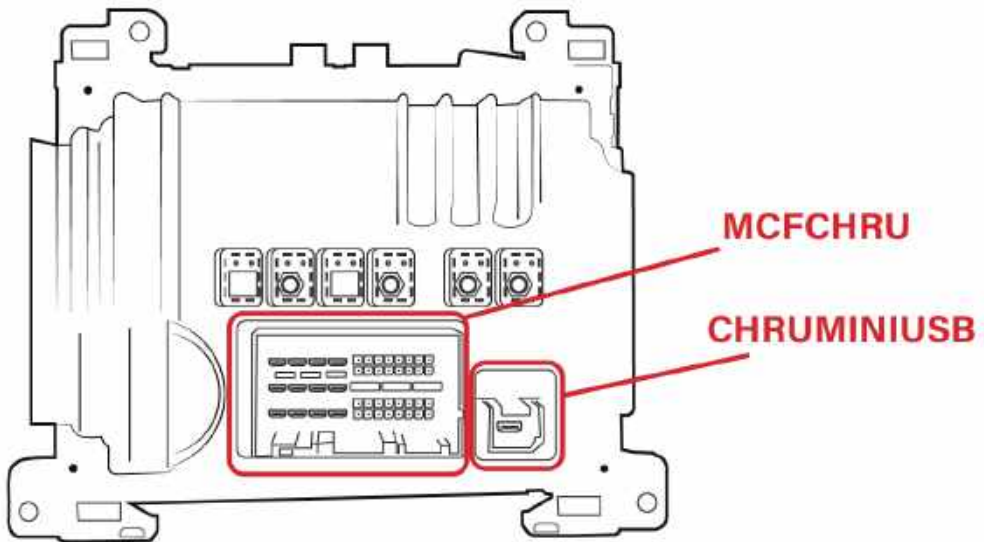

Connecting to the VLine

Route the unused end of the video and power cable MCFCHRU to the VLine module. Then, connect the 20-pin and 12-pin plugs of the MCFCHRU cable to the VLine ports.

Connect the 3.5 mm jack on the MCFCHRU harness to the VLine 3.5 mm jack, labeled MIC.

Connect the CHRUMINIUSB USB cable to the USB “pigtail” connector of the VLine module.

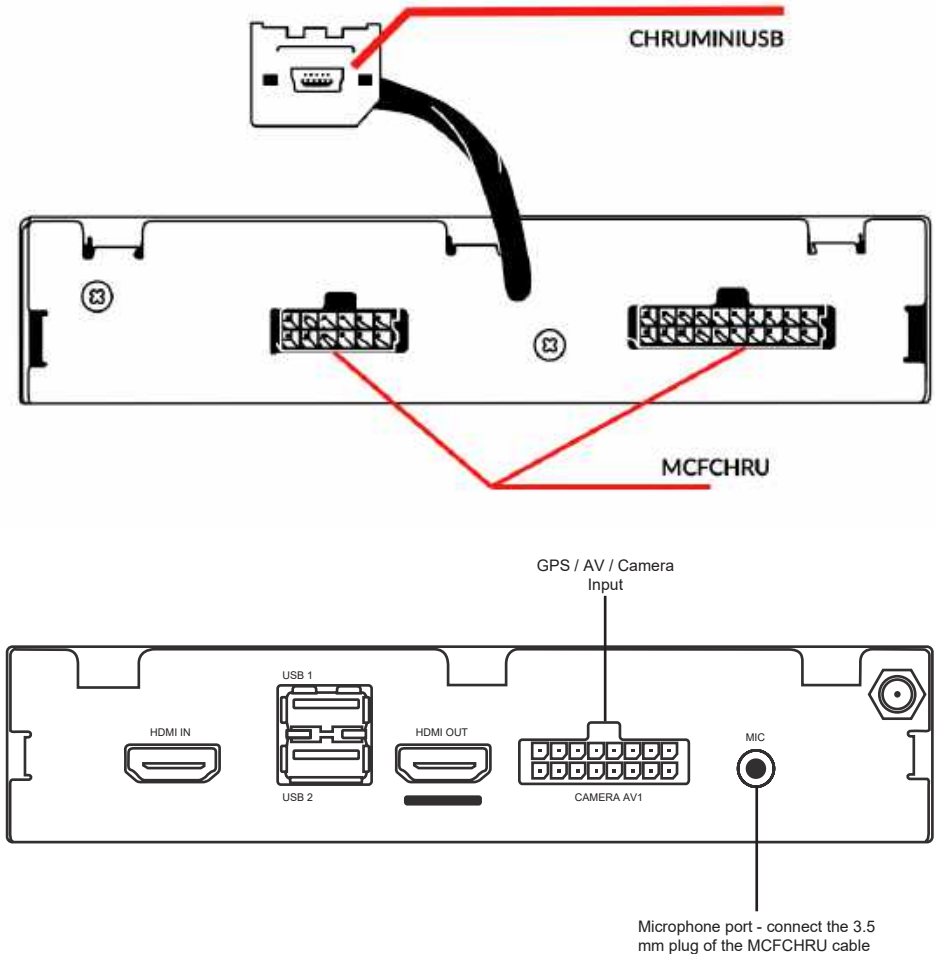

Position the main VLine unit inside the glove box for secure and accessible location.

Routing the GPS antenna

The GPS Antenna module comes with double-sided tape.

You can mount the GPS antenna on the top of the dashboard. We recommend mounting it inside the vehicle on the dashboard's passenger side, as shown below. Ensure the GPS antenna faces up and no metal obstructions are above it. Plug the GPS antenna into the Camera AV port of the VLine unit (see page 6).

If you need to use the VAUX RCA cable, carefully disconnect the GPS antenna from the small 16-pin molex extension, and plug the VAUX cable instead, per the instructions. Please do not break the GPS antenna when unplugging it from the molex extension. Replug the GPS antenna into the VAUX cable, as shown below.

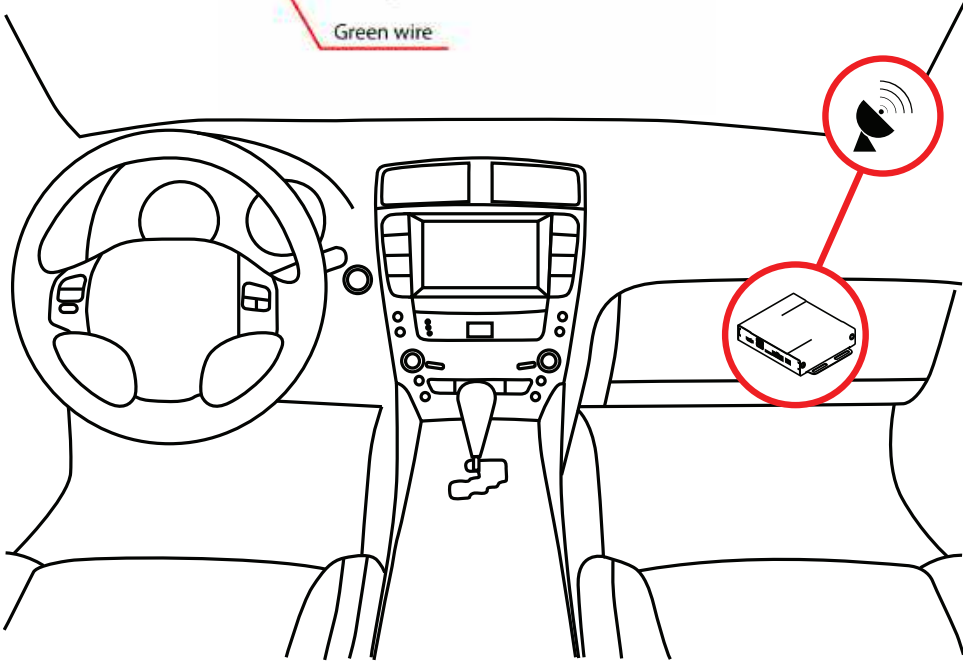
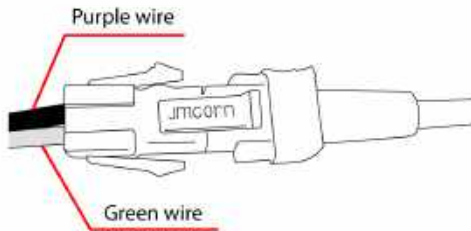

Using factory microphone

VLine will use a factory microphone for its operation. Therefore, ensure that you connect the 3.5 mm male connector of the MCFCHRU harness to the microphone port of the VLine (see p. 6 for eference).

Adjusting the microphone gain for CarPlay® or AAuto®

1. Go to the VLine home screen and tap on three horizontal lines in the upper left corner of the screen. You will get into the Settings Menu.
2. While in Settings, scroll down to the bottom of the screen.
3. Hit AUTO on the screen to automatically adjust the microphone gain.
4. Follow the instructions on the screen and adjust the microphone gain.

We recommend setting the microphone gain to 30-45 for the factory mic.

Testing VLine Operation

Test VLine operation before mounting the dashboard back. **WARNING:** Ensure to reconnect all unplugged connectors back to the vehicle before cycling the ignition.

Cycle the ignition and enter iPod USB mode of the stereo to get to the VLine operations.

If the VLine user interface appears on the screen and all factory functions such as the climate controls, reverse camera, and AF/FM radio, are working, you can mount the dashboard back.

Mounting the VLine module

Mount the VLine main module in an easily accessible location, such as the glove compartment, for easy access to the USB ports and to upgrade firmware on the VLine module. **Do not leave the unit inside the dashboard**, as it can damage the unit and its Bluetooth antenna and affect the Bluetooth / Wifi reception.

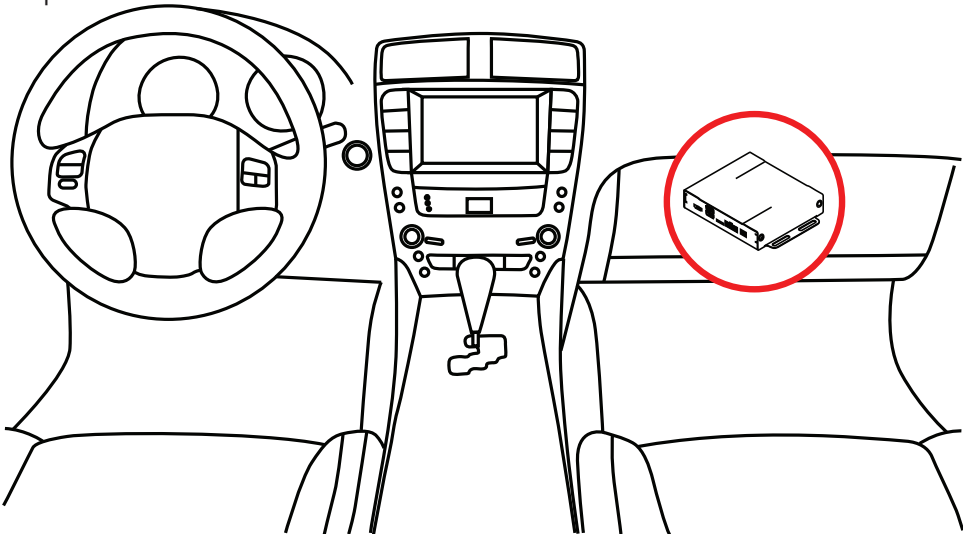

Understanding the VLine ports

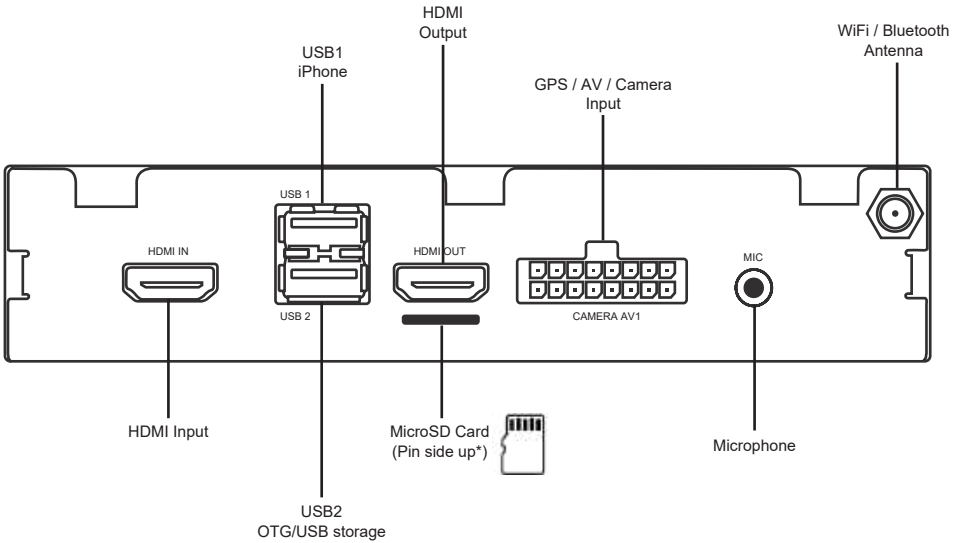

USB1

iPhone connection

Any other USB device (Keyboard / Mouse)

USB2

USB flash drive

Any USB device (Android, Keyboard / Mouse)

MicroSD

Insert microSD card (*pin side up) to increase storage space for Vline (up to 128GB supported). The microSD should be formatted FAT32. File system format exFAT and NTFS are not supported.



HDMI IN

HDMI input connection to connect external video sources.

(add plugin to Dashling Launcher to use feature)

HDMI OUT

HDMI Output connection to connect external displays. The HDMI Output will match the VLine's video feed and resolution, be sure your external display can handle those properly.

MIC

Microphone input, Connect 3.5mm Mono Microphone

CHAPTER 2 — GETTING STARTED

2.1 Functions

The GROM VLINE emulates the factory iPod USB mode of the stereo.

No important factory functions of the stereo will be disabled. Factory bluetooth, navigation, FM / AM radio, backup camera will keep working. Factory iPod USB will be disabled, but you can integrate the iPod or iPhone to your car stereo using VLine USB function.

Selecting the VLINE mode:

Use the Source button on the steering wheel controls, or navigate through the factory UI, to get to the iPod source of your car stereo.

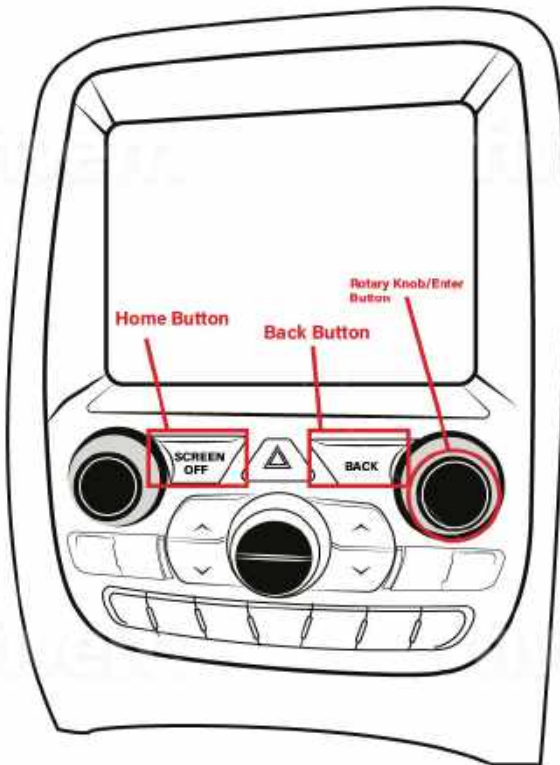

2.2 Android Auto

2.2.1 For USB connection: attach the Android phone to one of the USB ports on VLine VL2. Download Android Auto app on your phone, grant all permissions and allow all notifications. Use Android Auto plugin on VLine to enter Android Auto. If you experience any problems connecting, try using different, shorter, higher quality USB cable.

See video: <http://bit.ly/vline-android-auto>

2.2.2 For wireless connection: on the VLine UI go to Settings --> Connected Devices --> Click on Bluetooth and on Pair New Device

1. Then go to the Bluetooth settings on your Android phone. Tap "Pair New Device" and wait for VLine2 to appear. Hit pair and check "Allow the access to your contacts and phone history".

2. On the VLine screen you will see exactly the same pop-up. Check allow the "access to your contacts and phone history" as well, and hit pair on both - VLine and your phone.

3. Go back to VLine UI main screen and hit Android Auto icon. At the bottom of the Android Auto settings you will see your phone listed. Tap on it to connect.

See video: https://bit.ly/wireless_aa

2.2.3 Android Auto phone calls

VLine does not support the phone calls on Android Auto. Use factory phone system to connect to the phone calls. Pair and connect your phone's Bluetooth to VLine for Audio/Media, and to factory Bluetooth for the phone calls. You can accept, reject or initiate phone calls on Android Auto screen.

2.3 Adjusting Audio Bass, Treble, Balance/Fade for VLINE

Use the Factory UI icon to get to the factory UI and adjust the sound settings. While in the VLine VL2 main screen, press on empty PLUS sign and go to Shortcuts --> Factory UI. Press on the Factory UI to get the shortcut icon to the main VLine screen. Tap on the Factory UI icon, and the stereo will switch from the VLine interface into factory iPod USB interface. While in the factory iPod USB interface, you can adjust audio settings.

Press FM and then back to iPod to switch back into the VLine interface mode.

SUPPORT

For technical support please visit us at www.gromaudio.com/support.html and fill out the form.

For live support, please go to www.gromaudio.com.

Please check our FAQ at www.gromaudio.com/support/faq.html, videos and installs at www.gromaudio.com/installs/index.html.

WARRANTY

Eighteen (18) Month Limited Warranty

This warranty covers any supplied or manufactured parts of the product that, upon inspection by GROM Audio authorized personnel, is found to have failed in normal use due to defects in the material or workmanship. This warranty does not apply to the installation expenses. Attempting to service or modify this unit, operating this unit under conditions other than the recommended will render this warranty void.

Unless otherwise prescribed by law, GROM Audio shall not be liable for any personal injury, property damage and or any incidental or consequential damages of any kind (including water damage) resulting from malfunctions, defects, misuse, improper installation or alteration of this product.

All parts of this product are guaranteed for a period of 18 month as follows:

Within the first 18 months from the date of purchase, subject to the conditions above, GROM Audio will repair or replace the product at their discretion, if it is defective in the material or workmanship.

All customers should contact GROM Audio support team at <http://gromaudio.com/support.html> and obtain an RMA number and Return Instructions. All defective product returned to GROM Audio within warranty period must be accompanied by the original invoice (or copy). All shipping handling charges are non-refundable. Warranty does not cover normal tear and wear, damages due to negligence, improper installation, and operation.

WITHOUT RMA NUMBER THE RETURNS ARE NOT ACCEPTED!

LEGAL AGREEMENT and SAFETY DISCLAIMER

GROM AUDIO VLINE Infotainment Upgrade System (hereinafter referred to as 'GROM PRODUCT') and its related software. THIS IS A LEGAL AGREEMENT BETWEEN YOU, AS "THE END USER", AND GROM Audio ("GROM"). PLEASE CAREFULLY READ THE TERMS AND CONDITIONS OF THIS AGREEMENT BEFORE USING THE GROM PRODUCTS. BY USING THE GROM PRODUCT AND THE SOFTWARE INSTALLED ON THE GROM PRODUCT, YOU ARE AGREEING TO BE BOUND BY THE TERMS OF AGREEMENT. SINCE GROM DOES NOT INSTALL THIS EQUIPMENT, GROM DISCLAIMS ANY LIABILITY FOR IMPROPER INSTALLATION OF THE GROM PRODUCT. FURTHER, THE END USER ACKNOWLEDGES THAT THE PRODUCT AND ITS SOFTWARE ARE

NOT INHERENTLY DANGEROUS AND DO NOT PROVIDE ANY INHERENT RISKS AND THEREFORE POTENTIAL DAMAGES TO THE END-USER, OTHER THAN 'Fitness for its Purpose'. As manufacturers continuously develop and modify stereo receiver models, they may cause you to experience some technical difficulties. If the product does not operate properly, please contact technical department promptly at www.gromaudio.com/support.html

GRANT OF LICENSE

GROM grants to you a non-transferable, non-exclusive license to use the GROM PRODUCT and its software installed on the GROM PRODUCT (the "SOFTWARE") and the related documentation solely for your own personal use or for internal use by your business, only on such GROM PRODUCTS. You shall not copy, reverse engineer, translate, port, modify or make derivative works of the Software contained in the PRODUCT. You shall not loan, rent, disclose, publish, sell, assign, lease, sublicense, market or otherwise transfer the Software in the PRODUCT or use it in any manner not expressly authorized by this agreement. You shall not derive or attempt to derive the source code or structure of all or any portion of the Software in the PRODUCT by reverse engineering, disassembly, recompilation, or any other means. You shall not use the Software in the PRODUCT to operate a service bureau or for any other use involving the processing of data for other persons or entities. GROM and its licensor(s) shall retain all copyright, trade secret, patent and other proprietary ownership rights to the Software in the PRODUCT. You may transfer all of your license rights in the Software or the PRODUCT, the related documentation and a copy of this License Agreement And Warranty to another party, provided that the party reads and agrees to accept the terms and conditions of this License Agreement And Warranty.

OPERATIONAL WARNING AND SAFETY INSTRUCTIONS

(A) EXCEPT AS OTHERWISE CONTAINED HEREIN, the PRODUCTS and related documentation are provided to you, "AS IS". IN NO EVENT SHALL GROM BE LIABLE FOR ANY DAMAGES, CLAIM OR LOSS INCURRED BY YOU (INCLUDING WITHOUT LIMITATION, COMPENSATORY, INCIDENTAL, INDIRECT, SPECIAL, CONSEQUENTIAL, OR EXEMPLARY DAMAGES, LOST PROFITS, LOST SALES OR BUSINESS EXPENDITURES, INVESTMENTS, OR COMMITMENTS

IN CONNECTION WITH ANY BUSINESS, LOSS OF ANY GOODWILL, OR DAMAGES. THE TERM 'INCIDENTAL DAMAGES' REFERS TO THE EXPENSES OF TRANSPORTING THE PRODUCTS TO THE GROM AUDIO SERVICE CENTER, LOSS OF THE END-USERS [ORIGINAL PURCHASER'S] TIME, LOSS OF THE USE OF THE PRODUCT, BUS FARES, CAR RENTALS OR OTHER COSTS RELATED TO THE CARE AND CUSTODY OF THE PRODUCT. THE TERM 'CONSEQUENTIAL DAMAGES' REFERS TO THE COST OF REPAIRING OR REPLACING OTHER PROPERTY, WHICH IS DAMAGED WHEN THIS PRODUCT DOES NOT WORK PROPERLY, RESULTING FROM THE USE OR INABILITY TO USE THE PRODUCTS, INCLUDING ANY DAMAGES INCURRED DUE TO THE NEGLIGENT OPERATION OF A MOTOR VEHICLE, IN CONJUNCTION WITH THE USE OF SAID PRODUCTS. THE END USER ACKNOWLEDGES ITS RESPONSIBILITY FOR THE USE OF THE PRODUCT. THE ADDITION OF GROM PRODUCTS AND ANY AFTERMARKET EQUIPMENT MAY ENHANCE THE VALUE OF A VEHICLE OR CAUSE A THIRD-PARTY TO ILLEGALLY ATTEMPT TO REMOVE THE PRODUCTS AND AFTER-MARKET EQUIPMENT. GROM DISCLAIMS ANY LIABILITY RELATED TO SUCH THEFT AND POTENTIAL DAMAGE TO PROPERTY. IT IS THE END-USERS RESPONSIBILITY TO PROTECT ITS OWN PROPERTY. THE END-USER FURTHER ACKNOWLEDGES THAT THE OPERATION OF A MOTOR VEHICLE IS AN INHERENTLY DANGEROUS ACTIVITY, AND BY ITS USE OF GROM'S PRODUCTS, ACKNOWLEDGES THAT THE PRODUCTS ARE REMOTELY RELATED TO SAID MOTOR VEHICLE OPERATION, AND THUS ANY DAMAGES CAUSED TO THE DRIVER OF THE VEHICLE, THE VEHICLE ITSELF OR ANY THIRD-PARTY AND ITS PROPERTY IS NOT THE RESPONSIBILITY OF GROM, ITS AGENTS OR ITS PRINCIPALS AND IS THE SOLE RESPONSIBILITY OF THE DRIVER OF SAID VEHICLE.

YOU, THE END-USER, OR ANY OTHER DRIVER OF THE VEHICLE, IS SOLELY RESPONSIBLE FOR THE SAFE OPERATION OF THE VEHICLE AND THE SAFETY OF BOTH YOU AND THE PASSENGERS. FOR SAFETY PURPOSES, THE PRODUCT SHOULD NOT BE USED FOR THE DRIVER'S ENTERTAINMENT, WHILE THE VEHICLE IS BEING DRIVEN. SUCH USE COULD BE A DISTRACTION TO THE DRIVER, WHICH COULD CAUSE AN ACCIDENT LEADING TO SERIOUS INJURY OR DEATH. IF YOU, THE END-USER ALLOW ANOTHER PERSON TO USE THE VEHICLE, IT IS YOUR RESPONSIBILITY TO THOROUGHLY BRIEF THAT OTHER USER, ON THE SAFETY REQUIREMENTS FOR OPERATING THE VEHICLE AND THE PRODUCTS INSTALLED THEREIN.

(B) SAID DISCLAIMERS SHALL APPLY TO THE USE OF SAID PRODUCTS, EVEN IF GROM HAS BEEN INFORMED OF, KNEW OF, OR SHOULD HAVE KNOWN OF THE LIKELIHOOD OF SUCH DAMAGES. THIS LIMITATION APPLIES TO ALL

CAUSES OF ACTION IN THE AGGREGATE, INCLUDING WITHOUT LIMITATION: BREACH OF CONTRACT, BREACH OF WARRANTY, NEGLIGENCE, STRICT LIABILITY, MISREPRESENTATION AND OTHER TORTS. IF GROM'S WARRANTY DISCLAIMER OR LIMITATION OF LIABILITY SET FORTH IN THIS AGREEMENT SHALL, OR FOR ANY REASON WHATSOEVER, BE HELD UNENFORCEABLE OR INAPPLICABLE, YOU AND ANY OTHER END USER AGREE THAT GROM'S LIABILITY SHALL NOT EXCEED (70%) OF THE PRICE PAID FOR THE ENCLOSED GROM PRODUCT.

Some states do not allow the exclusion or limitation of incidental or consequential damages, so the above limitation or exclusion may not apply to you. This Warranty Disclaimer and Limitation of Liability shall not be applicable to the extent that any federal, state, or local law, which cannot be preempted, prohibits any provision of this Warranty.

Any use of the PRODUCTS where it is illegal to do so, may be used against you as evidence of negligence in the event of an auto accident or other traffic infraction.

By purchasing or otherwise obtaining GROM Product you agree:

- to operate GROM Products only when there are safe driving conditions;
- to follow any applicable state and traffic laws;
- to keep an eye on the road at all time while driving;
- do not attempt to play video (such as YouTube) on a display while the vehicle is in motion;
- do not use GROM Product without running the engine for the extended period of time as it can drain the battery.

You further agree to use the GROM Product in:

- a manner consistent with all applicable laws and regulations and this Agreement;
- a reasonable, safe and appropriate manner considering all the circumstances associated with that use.

You agree not to use the GROM Product:

- for any illegal, non-personal or unauthorized purpose,
- in a manner that could damage or cause risk to GROM Audio business,

reputation, employees, customers, facilities, or to any third party,

- in a manner that would distract the driver or that may otherwise cause injury or death to vehicle occupants or bystanders.

GROM Audio is not in any way responsible for any such use by you. In all cases, GROM Audio may limit or revoke your use for any reason and at any time. Use of some GROM Product features while a vehicle is in motion may be against the laws of the jurisdiction in which you use the GROM Product. Use of some GROM Product features by the driver or by the vehicle occupants while a vehicle is in motion may also be distracting to the driver and could cause serious injury or death to vehicle occupants or bystanders. IT IS ILLEGAL IN MOST STATES OF THE UNITED STATES AND MAY BE ILLEGAL IN OTHER JURISDICTIONS FOR ANY TELEVISION OR OTHER VIDEO DISPLAY, STREAM, TRANSMISSION OR BROADCAST TO BE VISIBLE TO THE DRIVER WHILE THE VEHICLE IS IN MOTION. YOU AGREE NOT TO USE ANY VISUAL COMPONENT OF GROM Product WHILE IN CONTROL OF A MOVING VEHICLE WHERE DOING SO WOULD BE ILLEGAL OR DANGEROUS TO VEHICLE OCCUPANTS OR BYSTANDERS. DOING OTHERWISE CAN LEAD TO SERIOUS INJURY OR DEATH TO YOU AND OTHERS. PLEASE FIND A SAFE PLACE TO PARK AND ENGAGE THE PARKING BRAKE BEFORE VIEWING ANY VIDEO DISPLAYS, STREAMS, TRANSMISSION, OR BROADCAST AVAILABLE THROUGH GROM Product.

THIRD PARTY MATERIALS

Through GROM Product, you can access third party websites, databases, networks, servers, information, software, programs, systems, directories, applications, products or services (collectively, "Third Party Materials"). GROM AUDIO is not responsible for any Third Party Materials available through the Services. You acknowledge and agree that GROM AUDIO does not have or maintain any control over Third Party Materials and is not responsible for examining or evaluating the content, accuracy, completeness, timeliness, validity, copyright compliance, legality, decency, quality or any other aspect of such Third Party Materials.

Third Party Materials may have their own terms of use and/or privacy policy, and may have different practices and requirements to those operated by GROM AUDIO with respect to GROM Product. You are responsible for reviewing any terms of use, privacy policy or other terms governing your use of these Third Party Materials, which you use at your own exclusive responsibility and risk. By using the Third Party Materials, you agree to comply with the use terms of the provider of such Third-Party Materials.

GROM AUDIO does not warrant or endorse and does not assume and will not have any liability or responsibility to you or any other person for any Third Party Materials or for any other materials, products, or services of third parties. By using the Third Party Materials, you agree to comply with the use terms of the provider of such Third-Party Materials.

LOCATION, MAPS, NAVIGATION AND TRAFFIC DATA

Location and traffic data provided by GROM Product is for basic navigational purposes only and is not intended to be relied upon in situations where precise location information is needed or where erroneous, inaccurate or incomplete location data may lead to death, personal injury, property or environmental damage. Real world traffic restrictions, advisories and conditions are always more important than guidance given by third party navigation/mapping data providers. Neither GROM Audio nor any of its content providers, guarantees the availability, accuracy, completeness, reliability, or timeliness of traffic information, navigation, or location data provided by the GROM Product. Always exercise the caution and common sense when using and relying on the navigation, location, maps and traffic data with GROM Product.

By using GROM Product you acknowledge that the maps, location, navigation and traffic data maybe inaccurate or outdated. You agree to hold GROM Audio harmless from any claims caused by inaccurate maps, location, navigation and traffic data. You further agree to use maps, location, navigation and traffic applications when it is safe to the driver, vehicle occupants and bypassers. GROM Audio is not responsible for any mobile data charges resulted from using GROM Product.

OTHER PROVISIONS

A. INDEMNIFICATION OF GROM AUDIO, ITS AGENTS AND EMPLOYEES. By Purchasing, Installing and Using the Products, You, the End- User, agree to indemnify, defend and hold harmless, GROM AUDIO, and its Affiliates, Directors, Officers, Agents and Employees from any Liabilities, Damage, Loss, Claim and Expense (including reasonable Attorney's Fees) arising out of the installation and use of the GROM Product.

B. EXCLUSION OF REMEDIES. TO THE MAXIMUM EXTENT PERMITTED UNDER APPLICABLE LAW, IN NO EVENT WILL GROM AUDIO OR ITS EMPLOYEES, DIRECTORS, OFFICERS AND OTHER REPRESENTATIVES BE LIABLE TO YOU OR ANYONE ELSE FOR ANY INDIRECT, SPECIAL, INCIDENTAL, PUNITIVE, EXEMPLARY OR CONSEQUENTIAL DAMAGES OF ANY KIND ARISING OUT OF OR IN ANY WAY RELATING TO THIS AGREEMENT, INCLUDING YOUR USE OF

OR INABILITY TO USE THE VLINE OR ANY CLAIM MADE BY A THIRD PARTY (INCLUDING, WITHOUT LIMITATION, LOSS OF REVENUE, PROFITS, DATA OR GOODWILL OR OTHER COMMERCIAL OR ECONOMIC LOSS) REGARDLESS OF THE CAUSE OF ACTION ON WHICH THE CLAIM IS BASED, EVEN IF GROM AUDIO HAS OR YOU HAVE BEEN ADVISED OF THE POSSIBILITY OF SUCH DAMAGES OR CLAIM.

C. GOVERNING LAW. THIS AGREEMENT and all Purchases hereunder shall be governed by, and construed under the laws of the State of California, without regard to conflicts of law rules. You agree that the Courts of California shall have exclusive jurisdiction over the Parties, for all disputes.

D. FORCE MAJEURE. GROM shall not be liable for any delay or failure in performance caused by or resulting from acts of God, fire, flood, storms, earthquakes, tornado, other acts of nature, any accidents, riots, wars, government intervention, embargoes, strikes, labor difficulties, equipment failures, or any other causes beyond the control of GROM AUDIO. Quantities are subject to availability.

E. ENTIRE AGREEMENT. These terms and conditions constitute the entire and exclusive agreement between you, the End-User and GROM AUDIO, concerning the Products, and your purchase hereunder, and supersede all statements or other agreements, whether oral or written, between you and GROM AUDIO. No change in this Agreement shall be effective, unless agreed to in writing by both, you, the end-user and GROM AUDIO.

GROM AUDIO COMPATIBILITY DISCLAIMER

GROM Audio strives to provide you with a high-quality product while maintaining competitive pricing. We continuously work to test and develop our product, however, in some cases; our interfaces may not be compatible with your application. Due to the wide range of electronics / anomalies found in car stereos, compatibility and/or controls may vary. Should you experience incompatibility issues, you may contact us via our support page. GROM Audio also carries a standard 30 day return policy.

ENGINE/SYSTEM NOISE DISCLAIMER

Engine / system noise may occur in some installations and is not easily predictable. Should noise occur with your system, we will take commercially-reasonable steps to diagnose the source of the noise. Depending on the situation, noise suppressors and filters may need to be installed in order to correct the problem. Due to the nature of electronics, noise may not be correctable in all cases.

IF YOU DO NOT AGREE WITH THESE TERMS AND PURCHASED DIRECTLY FROM GROM AUDIO PLEASE RETURN THE GROM PRODUCTS IN ORIGINAL CONDITION AND IN ORIGINAL PACKAGE WITHIN FIVE (5) BUSINESS DAYS OF RECEIPT OF THE PRODUCTS FOR A FULL REFUND OF THE PURCHASE PRICE OF GROM PRODUCTS (SHIPPING COSTS NON REFUNDABLE).

FCC Radio Frequency Exposure and Declaration of Conformity

This equipment has been tested and found to comply with the limits for a Class B digital device, pursuant to part 15 of the FCC Rules. These limits are designed to provide reasonable protection against harmful interference in a residential installation. This equipment generates, uses and can radiate radio frequency energy and, if not installed and used in accordance with the instructions, may cause harmful interference to radio communications.

However, there is no guarantee that interference will not occur in a particular installation. If this equipment does cause harmful interference to radio or television reception, which can be determined by turning the equipment off and on, the user is encouraged to try to correct the interference by one or more of the following measures:

- Reorient or relocate the receiving antenna.
- Increase the separation between the equipment and receiver.
- Connect the equipment into an outlet on a circuit different from that to which the receiver is connected.
- Consult the dealer or an experienced radio/TV technician for help.

WARNING: This equipment radiates radio frequency energy at a level below the United States FCC radio frequency exposure limits. Nevertheless, this device should be used in such a manner that the potential for human contact during normal operation is minimized.

The equipment must be installed to provide a separation distance of at least 20cm from people to ensure compliance with the RF exposure requirements.



DRIVE HAPPY

All trademarks or registered trademarks used in this manual are for informational purposes only. All trademarks are the property of the respective owners and are in no way associated with GROM Audio. CarPlay®, iPhone®, Siri® are registered trademarks of Apple, Inc.® Android Auto®, Android®, Google® are registered trademarks of Google, Inc.®