

# VLine

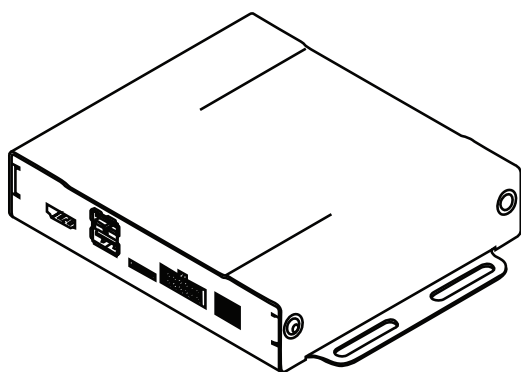

## INSTALLATION MANUAL

**LEX5**

# CONTENTS

Package contents.....	3
<b>CHAPTER 1 — INSTALLATION. ....</b>	<b>3</b>
1.1 Before Installation	3
1.2 Tools	3
1.3 Vehicle Installation	3
1.4 Safety Guidelines & Appropriate Use	4
Connect supplied Display Harness Cable to factory Display. ....	5
Connect VLine Interface cable to Factory Head unit. ....	6
Connecting to VLine.....	6
Routing the GPS Antenna.....	7
Routing the Microphone.....	8
Mounting the VLine Module.....	9
Understanding VLine Ports.....	10
<b>CHAPTER 2 — GETTING STARTED.....</b>	<b>11</b>
<b>SUPPORT. ....</b>	<b>13</b>
<b>WARRANTY.....</b>	<b>13</b>
EIGHTEEN MONTH (18) LIMITED WARRANTY	
<b>GRANT OF LICENSE.....</b>	<b>14</b>
<b>OPERATIONAL WARNING AND SAFETY INSTRUCTIONS. ....</b>	<b>15</b>

# GROM-VLINE SYSTEM

## PACKAGE CONTENTS

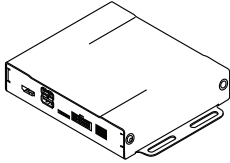

VLine module

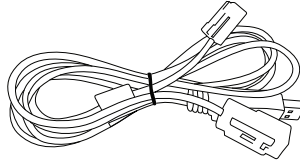

GVMF  
Display Harness

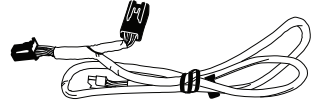

MCFTOY  
Power Harness

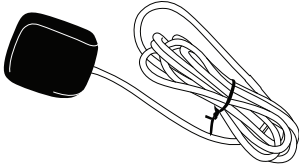

GPS Antenna

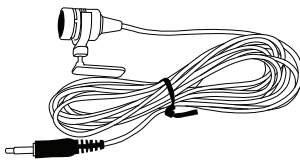

Microphone

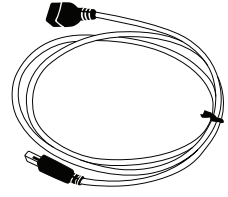

USB Extension cable

## CHAPTER 1 — INSTALLATION

### 1.1 Before Installation

Before starting work with any wiring, please wait 90 seconds after turning the Ignition to the OFF position and disconnecting the negative (-) terminal of the battery. This is to ensure that no SRS airbags faults are triggered during the installation when disassembling the vehicle's panels and wiring connections for the VLINE module installation.

Please review the entire manual to familiarize yourself of the VLINE module and the installation requirements before installing the unit and using it.

### 1.2 Tools

Have Tools ready for disassembling the dashboard panels to remove the stereo.

Some basic tools will be required for stereo removal and installation, Plastic prying tools, Phillips head screwdriver, 10mm socket and ratchet. Additional tools may be required depending on vehicle and installation preference.

### 1.3 Vehicle Installation

Each model vehicle disassembles differently. The removal of the stereo and

wiring installation requires special technical skills and experience. If you do not feel comfortable doing the installation please consult with your local car audio shop or installation professional for instructions or assistance if necessary.

Carefully remove the factory Stereo and Display out of the dash cavity with proper tools.

It may be necessary to disconnect items surrounding the stereo and display to remove them and gain access to the back of the stereo to make your connections.

## **1.4 Safety Guidelines & Appropriate Use**

By using VLine you agree:

- to operate VLine only when there are safe driving conditions;
- to follow any applicable state and traffic laws;
- to keep an eye on the road at all time while driving;
- do not attempt to play video (such as YouTube) on a display while the vehicle is in motion;
- do not use VLine without running the engine for the extended period of time as it can drain the battery.

Do not use Vline in a manner that would distract the driver or that may otherwise cause injury or death to vehicle occupants or bystanders.

IT IS ILLEGAL IN MOST STATES OF THE UNITED STATES AND MAY BE ILLEGAL IN OTHER JURISDICTIONS FOR ANY TELEVISION OR OTHER VIDEO DISPLAY, STREAM, TRANSMISSION OR BROADCAST TO BE VISIBLE TO THE DRIVER WHILE THE VEHICLE IS IN MOTION. YOU AGREE NOT TO USE ANY VISUAL COMPONENT OF VLine WHILE IN CONTROL OF A MOVING VEHICLE WHERE DOING SO WOULD BE ILLEGAL OR DANGEROUS TO VEHICLE OCCUPANTS OR BYSTANDERS. DOING OTHERWISE CAN LEAD TO SERIOUS INJURY OR DEATH TO YOU AND OTHERS. PLEASE FIND A SAFE PLACE TO PARK AND ENGAGE THE PARKING BRAKE BEFORE VIEWING ANY VIDEO DISPLAYS, STREAMS, TRANSMISSION, OR BROADCAST AVAILABLE THROUGH VLIN.

## Connect supplied Display Harness Cable to factory Display

Locate BLUE Display port on rear of Multi Display ECU.

If the port is Empty, plug in supplied video cable (GVMF) into port and leave female portion of cable with nothing attached.

If there is cable plugged in, disconnect factory Display cable (typically Blue in color). Then plug in supplied Y cable and reconnect disconnected cable into female plug of the supplied Display cable.

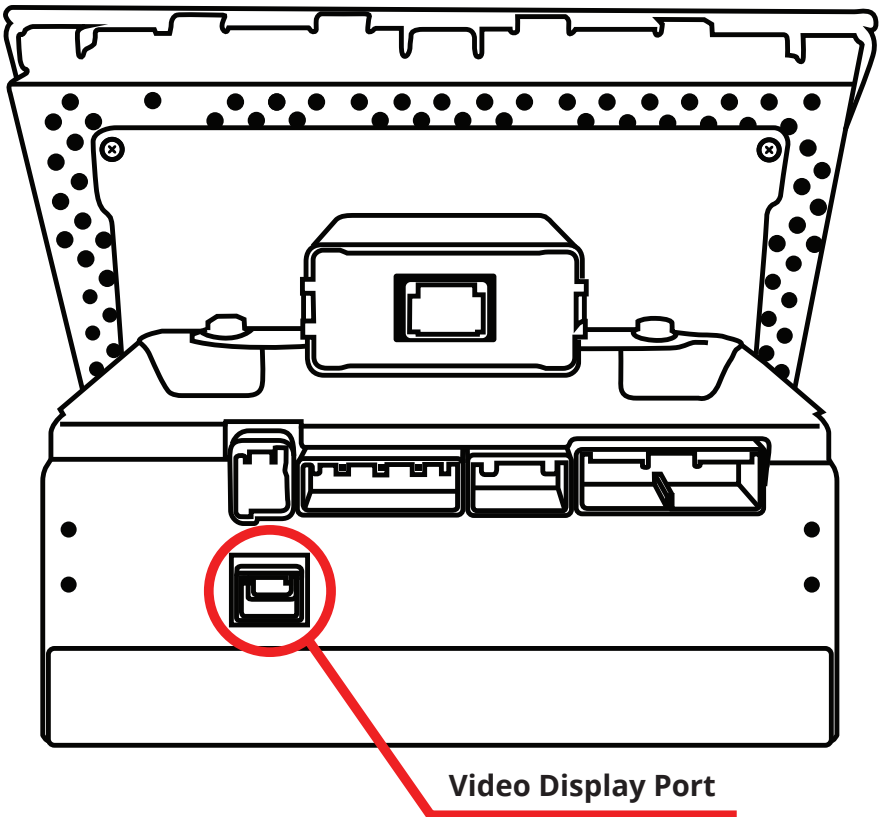

## Connect VLine Interface cable to Factory Head unit

Located 12-pin connector and unplug. Plug in supplied Power Audio Wiring Harness Interface cable (MCFTOY). Reconnect back what was disconnected from the rear of the stereo back into the female plug of the supplied interface cable.

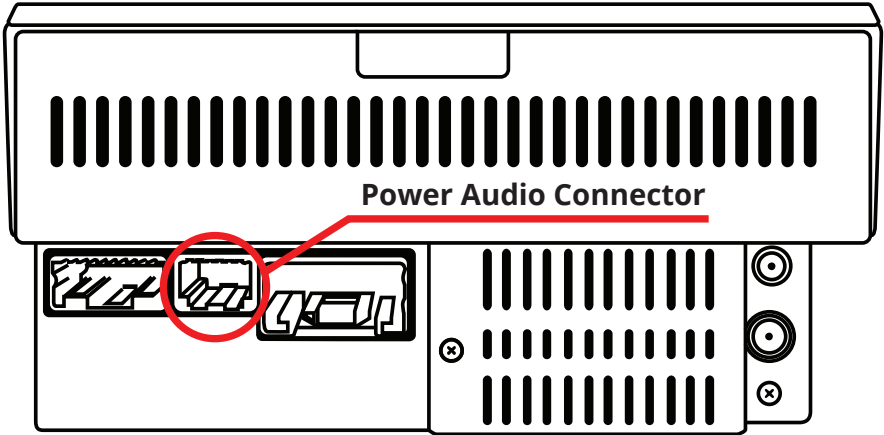

## Connecting to VLine

Route the unused end of Display Cable and Power Audio Cable to the VLine module and connect them to the correctly labeled ports.

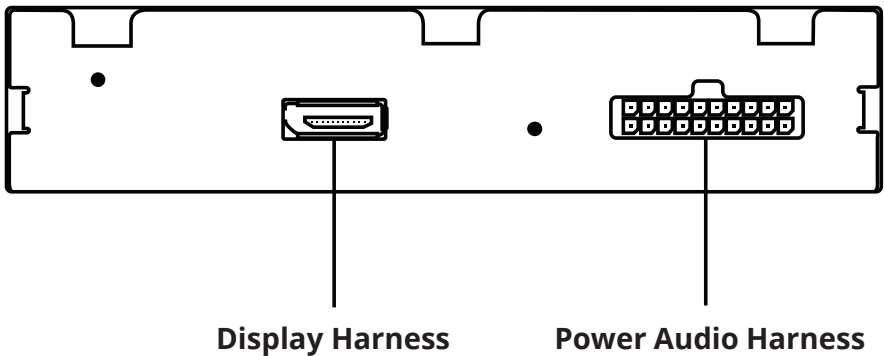

## Routing the GPS Antenna

The GPS Antenna module is magnetic as well as supplied with double sided tape.

It can be mounted to the top of dashboard or to outside of vehicle whichever you prefer. Route to desired location. We recommend mounting on inside of vehicle on passenger side of the Dashboard as shown below.

Plug the GPS antenna into the port labeled **CAMERA AV1** on the VLine Module

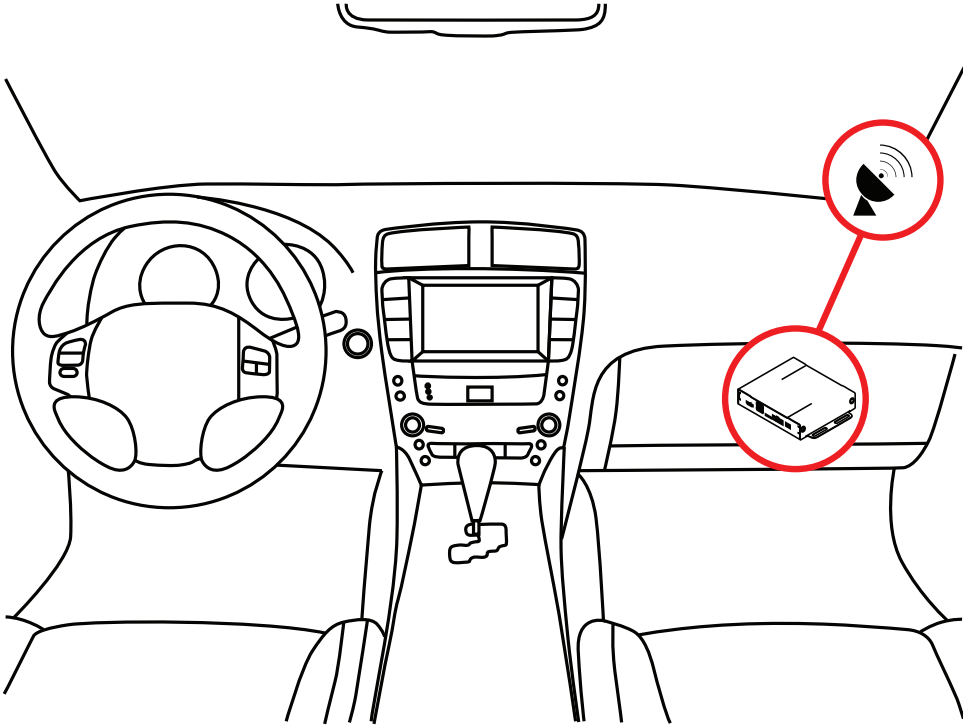

## Routing the Microphone

Route microphone to a location where it will be able to pick up voice clearly.

We recommend to mount MIC nearby the rear view mirror but not directly on windshield glass. Avoid sticking to the hard surface as it will pick up more noise.

Plug the microphone into the MIC port of the VLine module

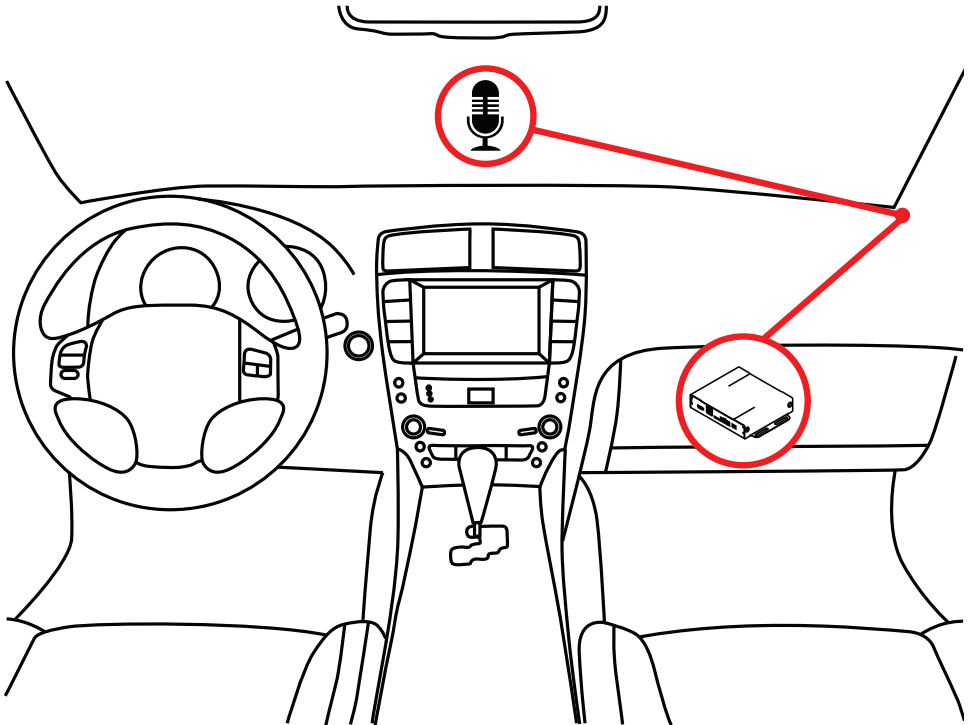



## Mounting the VLine Module

Mount module in location free of any moving parts. We strongly recommend mounting the module in an easily accessible location such as the glove compartment for easy access to the USB ports and in case of needing to upgrade firmware on the VLine module.

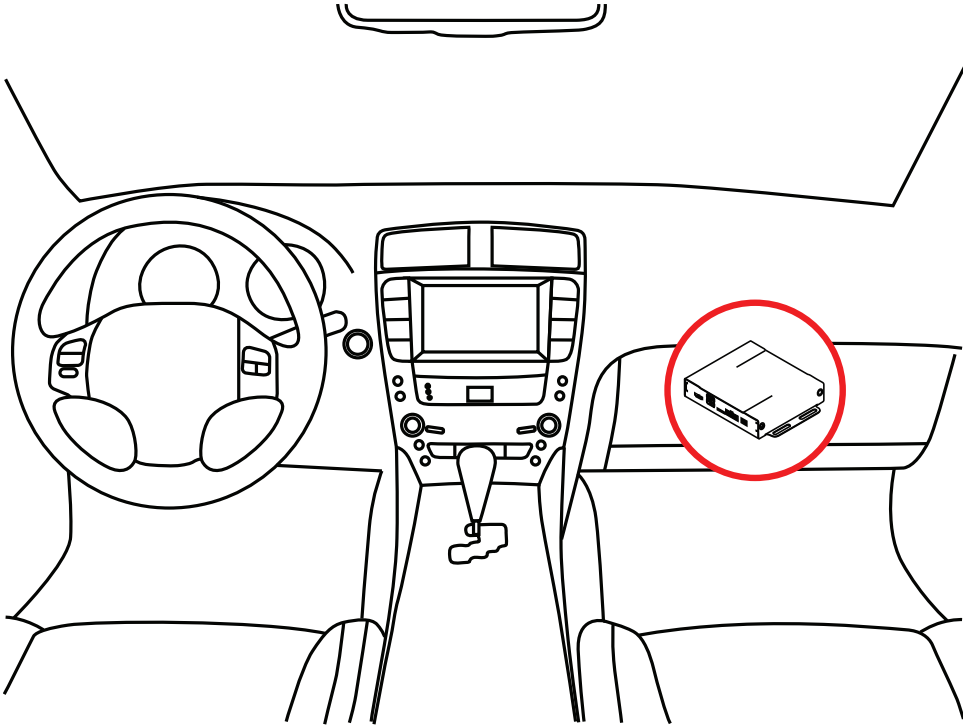

Securely mount and install the interface in a location free from heat, humidity, moving parts, or direct sunlight. Beware of hot-air flow from your vehicle's climate control system. The interface should be secured in a suitable location, free of sharp metal edges, using double-sided tape, Velcro, or wire ties. The adapter's operating temperature range is  $-30^{\circ}\text{C}$  to  $+70^{\circ}\text{C}$  ( $-24^{\circ}\text{F}$  to  $+158^{\circ}\text{F}$ )

# Understanding VLine Ports

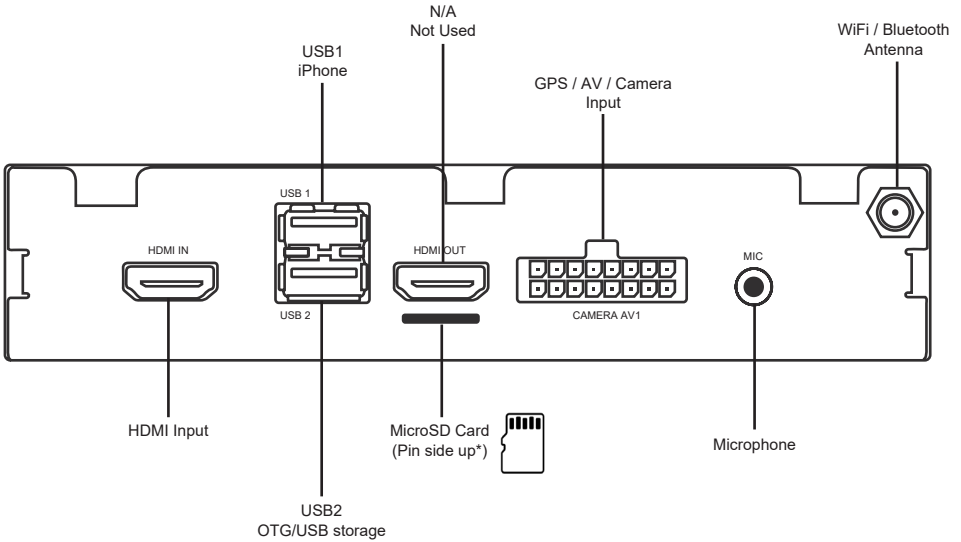

## USB1

iPhone connection

Any other USB device (Keyboard / Mouse)

## USB2

USB flash drive

Any USB device (Android, Keyboard / Mouse)

## MicroSD

Insert microSD card (\*pin side up) to increase storage space for Vline (up to 128GB supported). The microSD should be formatted FAT32. File system format exFAT and NTFS are not supported.

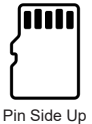

## HDMI IN

HDMI input connection to connect external video sources.  
(add plugin to Dashling Launcher to use feature)

## HDMI OUT

N/A, not used

## MIC

Microphone input, Connect 3.5mm Mono Microphone

## CHAPTER 2 — GETTING STARTED

### 2.1 Initializing

After connecting the VLine module to the stereo, an Ignition Cycle will have to be performed for the stereo to discover Vline and allow Vline to self configure.

#### To INITIALIZE:

1. Put Ignition Switch to “ACC” or “ON” position
2. Wait up to 5 Seconds
3. Put Ignition Switch to “OFF” position
4. Wait 1 minute
5. Turn Ignition Switch back to “ACC” or “ON” Position
6. Press the DISC button until you are able to select the VLINE interface.  
(may take more than 2 presses of the DISC for accessing as first press is for built-in CD/DVD changer in most cases)

### 2.2 Functions

The GROM VLINE emulates the factory external CD changer mode or USB mode of the stereo depending on vehicle year and model that it is installed into.

No factory functions of the stereo will be disabled. Factory Bluetooth, Navigation, Radio and CD player will remain functional.

#### Selecting the VLINE mode:

Press the DISC button to access the external CD changer mode of the stereo to enter into VLINE interface mode (may need to press DISC few times).

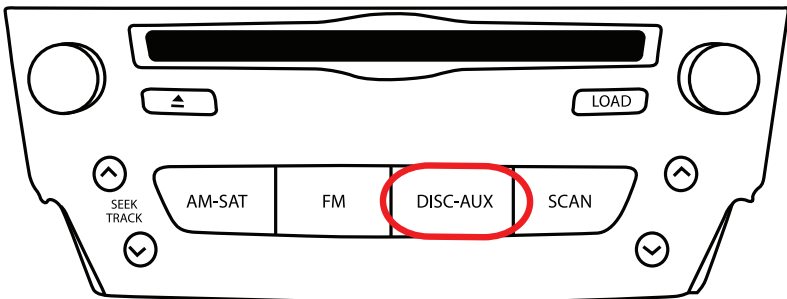

## Adjusting Audio Bass, Treble, Balance/Fade for VLINE Mode.

To adjust, press SCAN button 3 (three) times. Factory display will switch from VLine Interface into factory CD changer interface to adjust Audio settings.

Press SCAN button 3 (three) times again to switch back into VLine Interface mode again

Track selection can be done with the stereo's SEEK TRACK ^ and v buttons or steering wheel buttons.

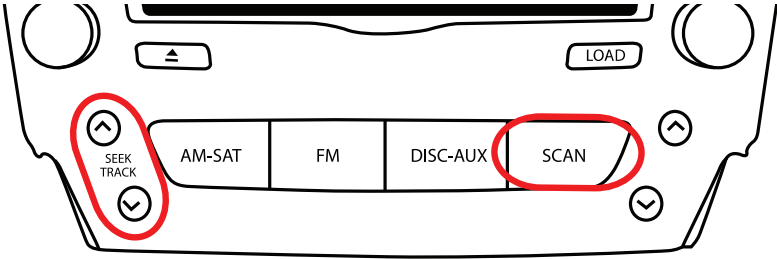

## User Manual

Please refer to the User Manual included with your purchase regarding to the next steps required to set up your VLine Infotainment System.

## **SUPPORT**

For technical support please visit us at [www.gromaudio.com/support.html](http://www.gromaudio.com/support.html) and fill out the form. For live support, please go to [www.gromaudio.com](http://www.gromaudio.com).

Please check our FAQ at [www.gromaudio.com/support/faq.html](http://www.gromaudio.com/support/faq.html), videos and installs at [www.gromaudio.com/installs/index.html](http://www.gromaudio.com/installs/index.html).

## **WARRANTY**

### **Eighteen (18) Month Limited Warranty**

This warranty covers any supplied or manufactured parts of the product that, upon inspection by GROM Audio authorized personnel, is found to have failed in normal use due to defects in the material or workmanship. This warranty does not apply to the installation expenses. Attempting to service or modify this unit, operating this unit under conditions other than the recommended will render this warranty void.

Unless otherwise prescribed by law, GROM Audio shall not be liable for any personal injury, property damage and or any incidental or consequential damages of any kind (including water damage) resulting from malfunctions, defects, misuse, improper installation or alteration of this product.

All parts of this product are guaranteed for a period of 18 month as follows:

Within the first 18 months from the date of purchase, subject to the conditions above, GROM Audio will repair or replace the product at their discretion, if it is defective in the material or workmanship.

All customers should contact GROM Audio support team at <http://gromaudio.com/support.html> and obtain an RMA number and Return Instructions. All defective product returned to GROM Audio within warranty period must be accompanied by the original invoice (or copy). All shipping handling charges are non-refundable. Warranty does not cover normal tear and wear, damages due to negligence, improper installation, and operation.

**WITHOUT RMA NUMBER THE RETURNS ARE NOT ACCEPTED!**

## **LEGAL AGREEMENT and SAFETY DISCLAIMER**

GROM AUDIO VLINE Infotainment Upgrade System (hereinafter referred to as 'GROM PRODUCT') and its related software. THIS IS A LEGAL AGREEMENT

BETWEEN YOU, AS "THE END USER", AND GROM Audio ("GROM"). PLEASE CAREFULLY READ THE TERMS AND CONDITIONS OF THIS AGREEMENT BEFORE USING THE GROM PRODUCTS. BY USING THE GROM PRODUCT AND THE SOFTWARE INSTALLED ON THE GROM PRODUCT, YOU ARE AGREEING TO BE BOUND BY THE TERMS OF AGREEMENT. SINCE GROM DOES NOT INSTALL THIS EQUIPMENT, GROM DISCLAIMS ANY LIABILITY FOR IMPROPER INSTALLATION OF THE GROM PRODUCT. FURTHER, THE END USER ACKNOWLEDGES THAT THE PRODUCT AND ITS SOFTWARE ARE NOT INHERENTLY DANGEROUS AND DO NOT PROVIDE ANY INHERENT RISKS AND THEREFORE POTENTIAL DAMAGES TO THE END-USER, OTHER THAN 'Fitness for its Purpose'. As manufacturers continuously develop and modify stereo receiver models, they may cause you to experience some technical difficulties. If the product does not operate properly, please contact technical department promptly at [www.gromaudio.com/support.html](http://www.gromaudio.com/support.html)

## **GRANT OF LICENSE**

GROM grants to you a non-transferable, non-exclusive license to use the GROM PRODUCT and its software installed on the GROM PRODUCT (the "SOFTWARE") and the related documentation solely for your own personal use or for internal use by your business, only on such GROM PRODUCTS. You shall not copy, reverse engineer, translate, port, modify or make derivative works of the Software contained in the PRODUCT. You shall not loan, rent, disclose, publish, sell, assign, lease, sublicense, market or otherwise transfer the Software in the PRODUCT or use it in any manner not expressly authorized by this agreement. You shall not derive or attempt to derive the source code or structure of all or any portion of the Software in the PRODUCT by reverse engineering, disassembly, recompilation, or any other means. You shall not use the Software in the PRODUCT to operate a service bureau or for any other use involving the processing of data for other persons or entities. GROM and its licensor(s) shall retain all copyright, trade secret, patent and other proprietary ownership rights to the Software in the PRODUCT. You may transfer all of your license rights in the Software or the PRODUCT, the related documentation and a copy of this License Agreement And Warranty to another party, provided that the party reads and agrees to accept the terms and conditions of this License Agreement And Warranty.

## **OPERATIONAL WARNING AND SAFETY INSTRUCTIONS**

(A) EXCEPT AS OTHERWISE CONTAINED HEREIN, the PRODUCTS and related documentation are provided to you, "AS IS". IN NO EVENT SHALL GROM BE LIABLE FOR ANY DAMAGES, CLAIM OR LOSS INCURRED BY YOU (INCLUDING WITHOUT LIMITATION, COMPENSATORY, INCIDENTAL, INDIRECT, SPECIAL, CONSEQUENTIAL, OR EXEMPLARY DAMAGES, LOST PROFITS, LOST SALES OR BUSINESS EXPENDITURES, INVESTMENTS, OR COMMITMENTS IN CONNECTION WITH ANY BUSINESS, LOSS OF ANY GOODWILL, OR DAMAGES. THE TERM 'INCIDENTAL DAMAGES' REFERS TO THE EXPENSES OF TRANSPORTING THE PRODUCTS TO THE GROM AUDIO SERVICE CENTER, LOSS OF THE END-USERS [ORIGINAL PURCHASER'S] TIME, LOSS OF THE USE OF THE PRODUCT, BUS FARES, CAR RENTALS OR OTHER COSTS RELATED TO THE CARE AND CUSTODY OF THE PRODUCT. THE TERM 'CONSEQUENTIAL DAMAGES' REFERS TO THE COST OF REPAIRING OR REPLACING OTHER PROPERTY, WHICH IS DAMAGED WHEN THIS PRODUCT DOES NOT WORK PROPERLY, RESULTING FROM THE USE OR INABILITY TO USE THE PRODUCTS, INCLUDING ANY DAMAGES INCURRED DUE TO THE NEGLIGENT OPERATION OF A MOTOR VEHICLE, IN CONJUNCTION WITH THE USE OF SAID PRODUCTS. THE END USER ACKNOWLEDGES ITS RESPONSIBILITY FOR THE USE OF THE PRODUCT. THE ADDITION OF GROM PRODUCTS AND ANY AFTER-MARKET EQUIPMENT MAY ENHANCE THE VALUE OF A VEHICLE OR CAUSE A THIRD-PARTY TO ILLEGALLY ATTEMPT TO REMOVE THE PRODUCTS AND AFTER-MARKET EQUIPMENT. GROM DISCLAIMS ANY LIABILITY RELATED TO SUCH THEFT AND POTENTIAL DAMAGE TO PROPERTY. IT IS THE END-USERS RESPONSIBILITY TO PROTECT ITS OWN PROPERTY. THE END-USER FURTHER ACKNOWLEDGES THAT THE OPERATION OF A MOTOR VEHICLE IS AN INHERENTLY DANGEROUS ACTIVITY, AND BY ITS USE OF GROM'S PRODUCTS, ACKNOWLEDGES THAT THE PRODUCTS ARE REMOTELY RELATED TO SAID MOTOR VEHICLE OPERATION, AND THUS ANY DAMAGES CAUSED TO THE DRIVER OF THE VEHICLE, THE VEHICLE ITSELF OR ANY THIRD-PARTY AND ITS PROPERTY IS NOT THE RESPONSIBILITY OF GROM, ITS AGENTS OR ITS PRINCIPALS AND IS THE SOLE RESPONSIBILITY OF THE DRIVER OF SAID VEHICLE.

YOU, THE END-USER, OR ANY OTHER DRIVER OF THE VEHICLE, IS SOLELY RESPONSIBLE FOR THE SAFE OPERATION OF THE VEHICLE AND THE SAFETY OF BOTH YOU AND THE PASSENGERS. FOR SAFETY PURPOSES, THE PRODUCT SHOULD NOT BE USED FOR THE DRIVER'S ENTERTAINMENT, WHILE THE VEHICLE IS BEING DRIVEN. SUCH USE COULD BE A DISTRACTION TO THE DRIVER, WHICH COULD CAUSE AN ACCIDENT LEADING TO SERIOUS

INJURY OR DEATH. IF YOU, THE END-USER ALLOW ANOTHER PERSON TO USE THE VEHICLE, IT IS YOUR RESPONSIBILITY TO THOROUGHLY BRIEF THAT OTHER USER, ON THE SAFETY REQUIREMENTS FOR OPERATING THE VEHICLE AND THE PRODUCTS INSTALLED THEREIN.

(B) SAID DISCLAIMERS SHALL APPLY TO THE USE OF SAID PRODUCTS, EVEN IF GROM HAS BEEN INFORMED OF, KNEW OF, OR SHOULD HAVE KNOWN OF THE LIKELIHOOD OF SUCH DAMAGES. THIS LIMITATION APPLIES TO ALL CAUSES OF ACTION IN THE AGGREGATE, INCLUDING WITHOUT LIMITATION: BREACH OF CONTRACT, BREACH OF WARRANTY, NEGLIGENCE, STRICT LIABILITY, MISREPRESENTATION AND OTHER TORTS. IF GROM'S WARRANTY DISCLAIMER OR LIMITATION OF LIABILITY SET FORTH IN THIS AGREEMENT SHALL, OR FOR ANY REASON WHATSOEVER, BE HELD UNENFORCEABLE OR INAPPLICABLE, YOU AND ANY OTHER END USER AGREE THAT GROM'S LIABILITY SHALL NOT EXCEED (70%) OF THE PRICE PAID FOR THE ENCLOSED GROM PRODUCT.

Some states do not allow the exclusion or limitation of incidental or consequential damages, so the above limitation or exclusion may not apply to you. This Warranty Disclaimer and Limitation of Liability shall not be applicable to the extent that any federal, state, or local law, which cannot be preempted, prohibits any provision of this Warranty.

Any use of the PRODUCTS where it is illegal to do so, may be used against you as evidence of negligence in the event of an auto accident or other traffic infraction.

**By purchasing or otherwise obtaining GROM Product you agree:**

- to operate GROM Products only when there are safe driving conditions;
- to follow any applicable state and traffic laws;
- to keep an eye on the road at all time while driving;
- do not attempt to play video (such as YouTube) on a display while the vehicle is in motion;
- do not use GROM Product without running the engine for the extended period of time as it can drain the battery.

You further agree to use the GROM Product in:

- a manner consistent with all applicable laws and regulations and this Agreement;



- a reasonable, safe and appropriate manner considering all the circumstances associated with that use.

You agree not to use the GROM Product:

- for any illegal, non-personal or unauthorized purpose,
- in a manner that could damage or cause risk to GROM Audio business, reputation, employees, customers, facilities, or to any third party,
- in a manner that would distract the driver or that may otherwise cause injury or death to vehicle occupants or bystanders.

GROM Audio is not in any way responsible for any such use by you. In all cases, GROM Audio may limit or revoke your use for any reason and at any time. Use of some GROM Product features while a vehicle is in motion may be against the laws of the jurisdiction in which you use the GROM Product. Use of some GROM Product features by the driver or by the vehicle occupants while a vehicle is in motion may also be distracting to the driver and could cause serious injury or death to vehicle occupants or bystanders. IT IS ILLEGAL IN MOST STATES OF THE UNITED STATES AND MAY BE ILLEGAL IN OTHER JURISDICTIONS FOR ANY TELEVISION OR OTHER VIDEO DISPLAY, STREAM, TRANSMISSION OR BROADCAST TO BE VISIBLE TO THE DRIVER WHILE THE VEHICLE IS IN MOTION. YOU AGREE NOT TO USE ANY VISUAL COMPONENT OF GROM Product WHILE IN CONTROL OF A MOVING VEHICLE WHERE DOING SO WOULD BE ILLEGAL OR DANGEROUS TO VEHICLE OCCUPANTS OR BYSTANDERS. DOING OTHERWISE CAN LEAD TO SERIOUS INJURY OR DEATH TO YOU AND OTHERS. PLEASE FIND A SAFE PLACE TO PARK AND ENGAGE THE PARKING BRAKE BEFORE VIEWING ANY VIDEO DISPLAYS, STREAMS, TRANSMISSION, OR BROADCAST AVAILABLE THROUGH GROM Product.

## **THIRD PARTY MATERIALS**

Through GROM Product, you can access third party websites, databases, networks, servers, information, software, programs, systems, directories, applications, products or services (collectively, "Third Party Materials"). GROM AUDIO is not responsible for any Third Party Materials available through the Services. You acknowledge and agree that GROM AUDIO does not have or maintain any control over Third Party Materials and is not responsible for examining or evaluating the content, accuracy, completeness, timeliness, validity, copyright compliance, legality, decency, quality or any other aspect of

such Third Party Materials.

Third Party Materials may have their own terms of use and/or privacy policy, and may have different practices and requirements to those operated by GROM AUDIO with respect to GROM Product. You are responsible for reviewing any terms of use, privacy policy or other terms governing your use of these Third Party Materials, which you use at your own exclusive responsibility and risk. By using the Third Party Materials, you agree to comply with the use terms of the provider of such Third-Party Materials.

GROM AUDIO does not warrant or endorse and does not assume and will not have any liability or responsibility to you or any other person for any Third Party Materials or for any other materials, products, or services of third parties. By using the Third Party Materials, you agree to comply with the use terms of the provider of such Third-Party Materials.

## **LOCATION, MAPS, NAVIGATION AND TRAFFIC DATA**

Location and traffic data provided by GROM Product is for basic navigational purposes only and is not intended to be relied upon in situations where precise location information is needed or where erroneous, inaccurate or incomplete location data may lead to death, personal injury, property or environmental damage. Real world traffic restrictions, advisories and conditions are always more important than guidance given by third party navigation/mapping data providers. Neither GROM Audio nor any of its content providers, guarantees the availability, accuracy, completeness, reliability, or timeliness of traffic information, navigation, or location data provided by the GROM Product. Always exercise the caution and common sense when using and relying on the navigation, location, maps and traffic data with GROM Product.

By using GROM Product you acknowledge that the maps, location, navigation and traffic data maybe inaccurate or outdated. You agree to hold GROM Audio harmless from any claims caused by inaccurate maps, location, navigation and traffic data. You further agree to use maps, location, navigation and traffic applications when it is safe to the driver, vehicle occupants and bypassers. GROM Audio is not responsible for any mobile data charges resulted from using GROM Product.

## **OTHER PROVISIONS**

A. INDEMNIFICATION OF GROM AUDIO, ITS AGENTS AND EMPLOYEES. By Purchasing, Installing and Using the Products, You, the End- User, agree to indemnify, defend and hold harmless, GROM AUDIO, and its Affiliates, Directors, Officers, Agents and Employees from any Liabilities, Damage, Loss, Claim and Expense (including reasonable Attorney's Fees) arising out of the installation and use of the GROM Product.

B. EXCLUSION OF REMEDIES. TO THE MAXIMUM EXTENT PERMITTED UNDER APPLICABLE LAW, IN NO EVENT WILL GROM AUDIO OR ITS EMPLOYEES, DIRECTORS, OFFICERS AND OTHER REPRESENTATIVES BE LIABLE TO YOU OR ANYONE ELSE FOR ANY INDIRECT, SPECIAL, INCIDENTAL, PUNITIVE, EXEMPLARY OR CONSEQUENTIAL DAMAGES OF ANY KIND ARISING OUT OF OR IN ANY WAY RELATING TO THIS AGREEMENT, INCLUDING YOUR USE OF OR INABILITY TO USE THE VLINE OR ANY CLAIM MADE BY A THIRD PARTY (INCLUDING, WITHOUT LIMITATION, LOSS OF REVENUE, PROFITS, DATA OR GOODWILL OR OTHER COMMERCIAL OR ECONOMIC LOSS) REGARDLESS OF THE CAUSE OF ACTION ON WHICH THE CLAIM IS BASED, EVEN IF GROM AUDIO HAS OR YOU HAVE BEEN ADVISED OF THE POSSIBILITY OF SUCH DAMAGES OR CLAIM.

C. GOVERNING LAW. THIS AGREEMENT and all Purchases hereunder shall be governed by, and construed under the laws of the State of California, without regard to conflicts of law rules. You agree that the Courts of California shall have exclusive jurisdiction over the Parties, for all disputes.

D. FORCE MAJEURE. GROM shall not be liable for any delay or failure in performance caused by or resulting from acts of God, fire, flood, storms, earthquakes, tornado, other acts of nature, any accidents, riots, wars, government intervention, embargoes, strikes, labor difficulties, equipment failures, or any other causes beyond the control of GROM AUDIO. Quantities are subject to availability.

E. ENTIRE AGREEMENT. These terms and conditions constitute the entire and exclusive agreement between you, the End-User and GROM AUDIO, concerning the Products, and your purchase hereunder, and supersede all statements or other agreements, whether oral or written, between you and GROM AUDIO. No change in this Agreement shall be effective, unless agreed to in writing by both, you, the end-user and GROM AUDIO.

## **GROM AUDIO COMPATIBILITY DISCLAIMER**

GROM Audio strives to provide you with a high-quality product while

maintaining competitive pricing. We continuously work to test and develop our product, however, in some cases; our interfaces may not be compatible with your application. Due to the wide range of electronics / anomalies found in car stereos, compatibility and/or controls may vary. Should you experience incompatibility issues, you may contact us via our support page. GROM Audio also carries a standard 30 day return policy.

## **ENGINE/SYSTEM NOISE DISCLAIMER**

Engine / system noise may occur in some installations and is not easily predictable. Should noise occur with your system, we will take commercially-reasonable steps to diagnose the source of the noise. Depending on the situation, noise suppressors and filters may need to be installed in order to correct the problem. Due to the nature of electronics, noise may not be correctable in all cases.

IF YOU DO NOT AGREE WITH THESE TERMS AND PURCHASED DIRECTLY FROM GROM AUDIO PLEASE RETURN THE GROM PRODUCTS IN ORIGINAL CONDITION AND IN ORIGINAL PACKAGE WITHIN FIVE (5) BUSINESS DAYS OF RECEIPT OF THE PRODUCTS FOR A FULL REFUND OF THE PURCHASE PRICE OF GROM PRODUCTS (SHIPPING COSTS NON REFUNDABLE).

\*iPod®, iPhone®, iPad® are registered trademarks of Apple, Inc. Android® is the registered trademark of Google, Inc. All trademarks or registered trademarks used in this manual are for informational purposes only.